

3. 도면

강의보기



3

자격종목	에너지관리기능장	과제명	강관 및 동관 조립	척도	N.S
------	----------	-----	------------	----	-----

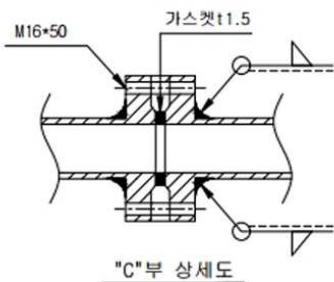
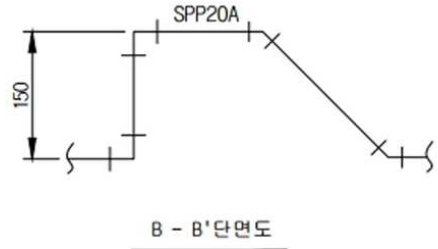
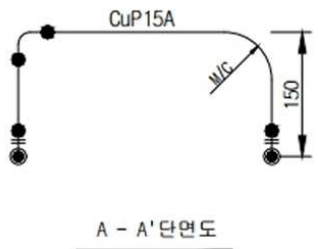
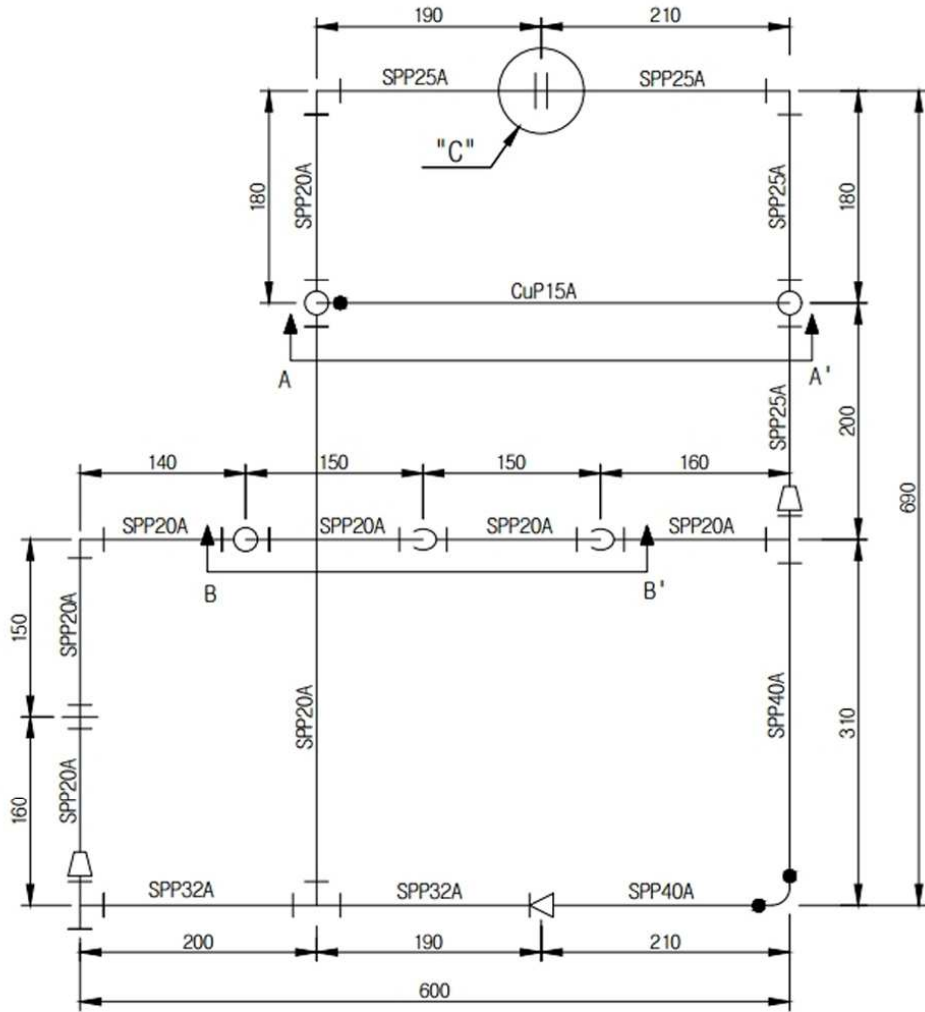

빨간이 계산란



자격종목	에너지관리기능장	과제명	강관 및 동관 조립	척도	N.S
------	----------	-----	------------	----	-----

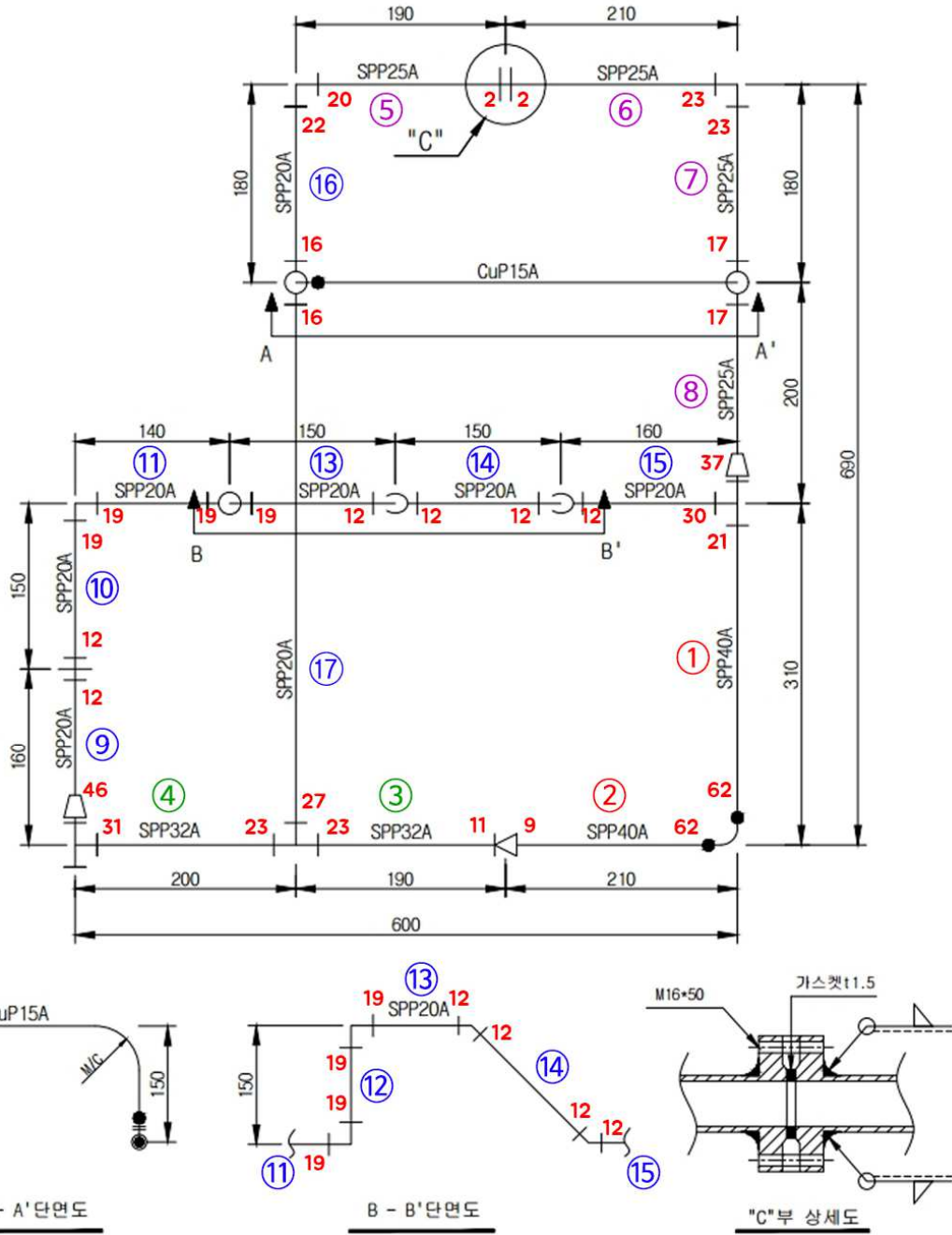

빨간색이 계산란		
40A	①	$310 - (21 + 62) = 227$
	②	$210 - (62 + 9) = 139$
32A	③	$190 - (11 + 23) = 156$
	④	$200 - (23 + 31) = 146$
25A	⑤	$190 - (20 + 2) = 168$
	⑥	$210 - (2 + 23) = 185$
	⑦	$180 - (23 + 17) = 140$
	⑧	$200 - (17 + 37) = 146$
20A	⑨	$160 - (46 + 12) = 102$
	⑩	$150 - (12 + 19) = 119$
	⑪	$140 - (19 + 19) = 102$
	⑫	$150 - (19 + 19) = 112$
	⑬	$150 - (19 + 12) = 119$
	⑭	$212 - (12 + 12) = 188$
	⑮	$160 - (12 + 30) = 118$
	⑯	$180 - (22 + 16) = 142$
	⑰	$510 - (16 + 27) = 467$

3. 도면

자 격 종 목	에 너 지 관 리 기 능 장	과 제 명	강관 및 동관 조립	척도	N.S
---------	-----------------	-------	------------	----	-----

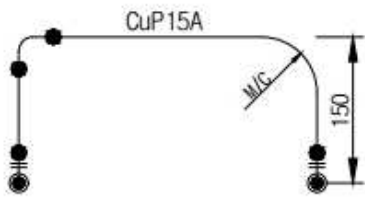
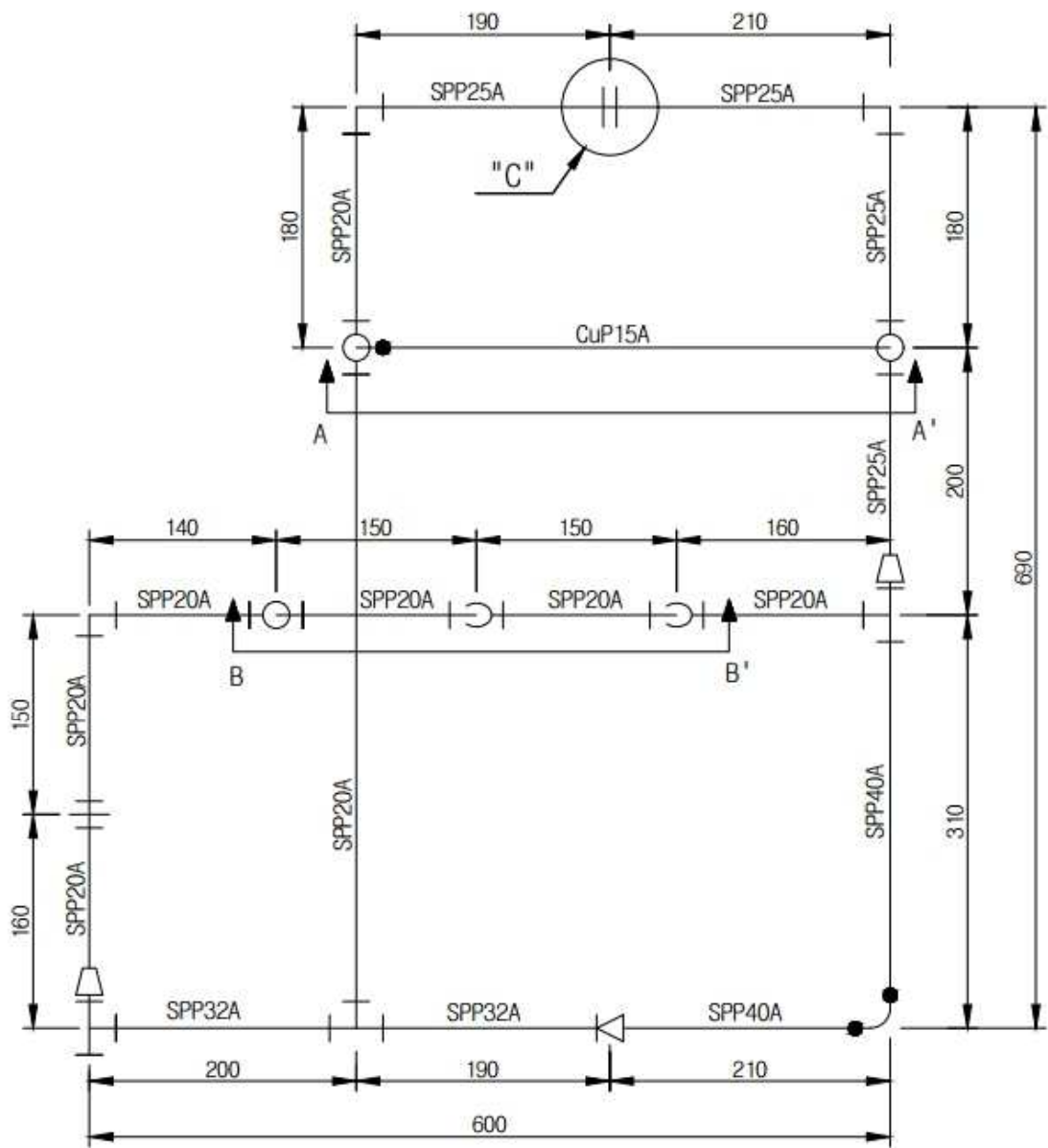

A - A' 단면도

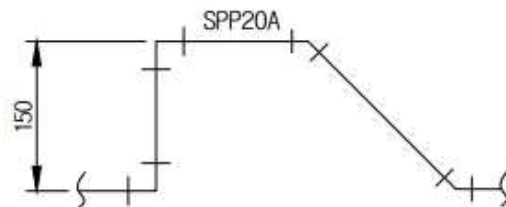

B - B' 단면도

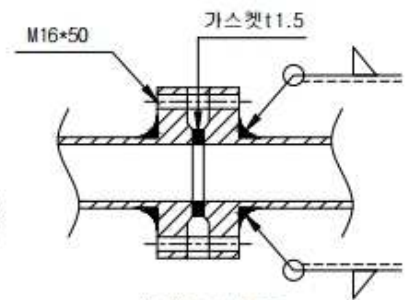

"C"부 상세도