

—
—

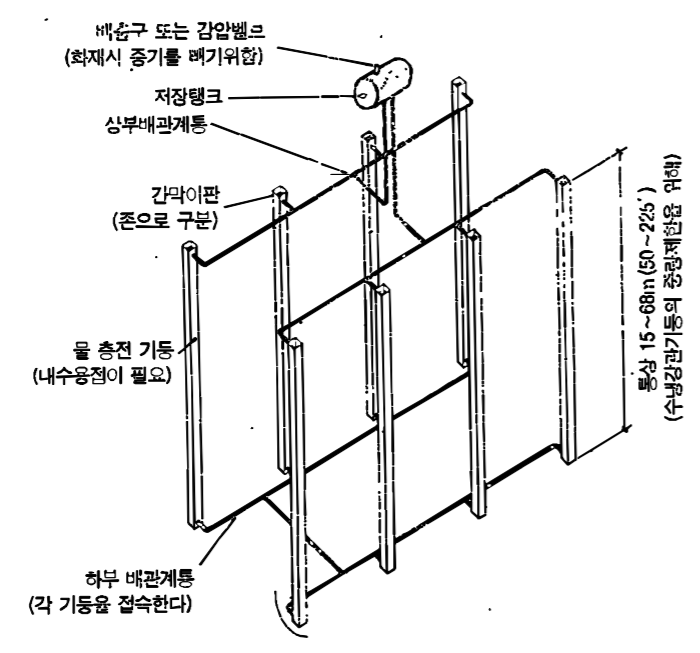

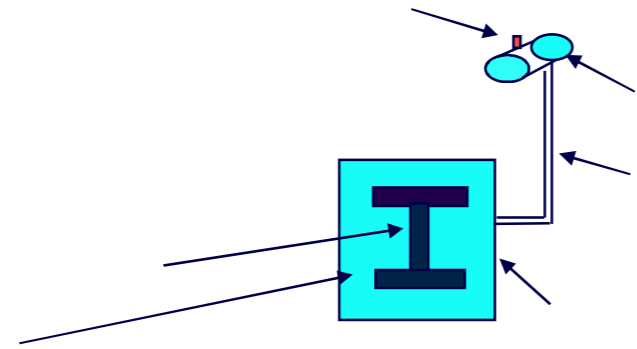

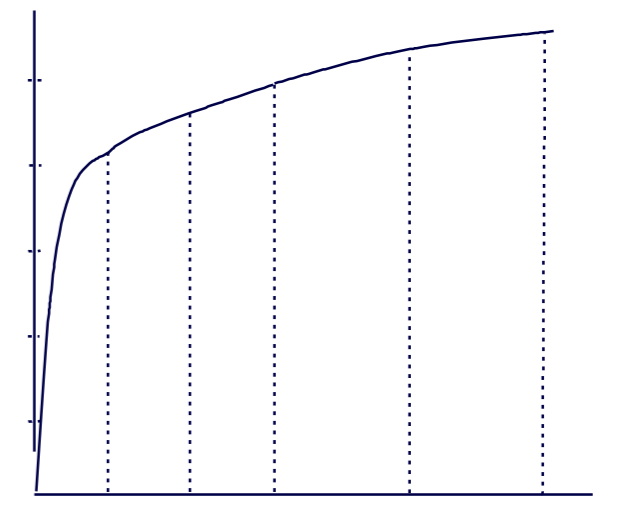
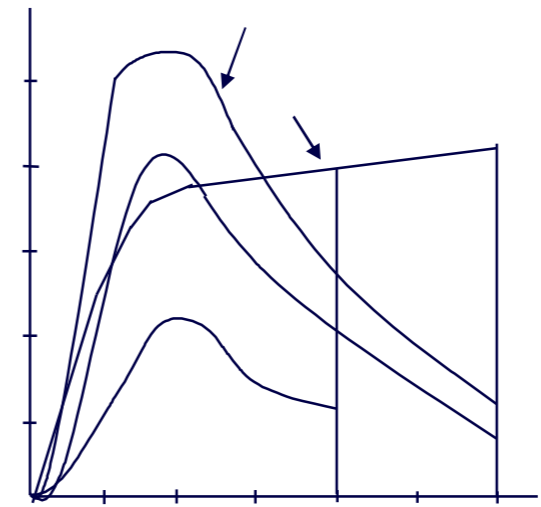
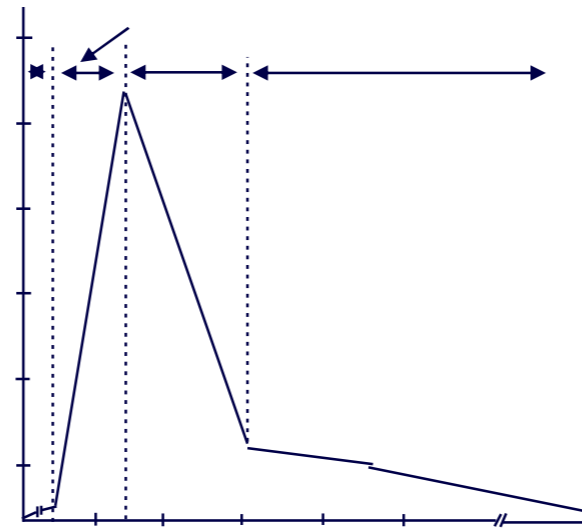

θ θ
 θ
 θ

	$\sqrt{\quad}$	$\sqrt{\quad}$

	$\Sigma \quad \Sigma$	
	Σ	

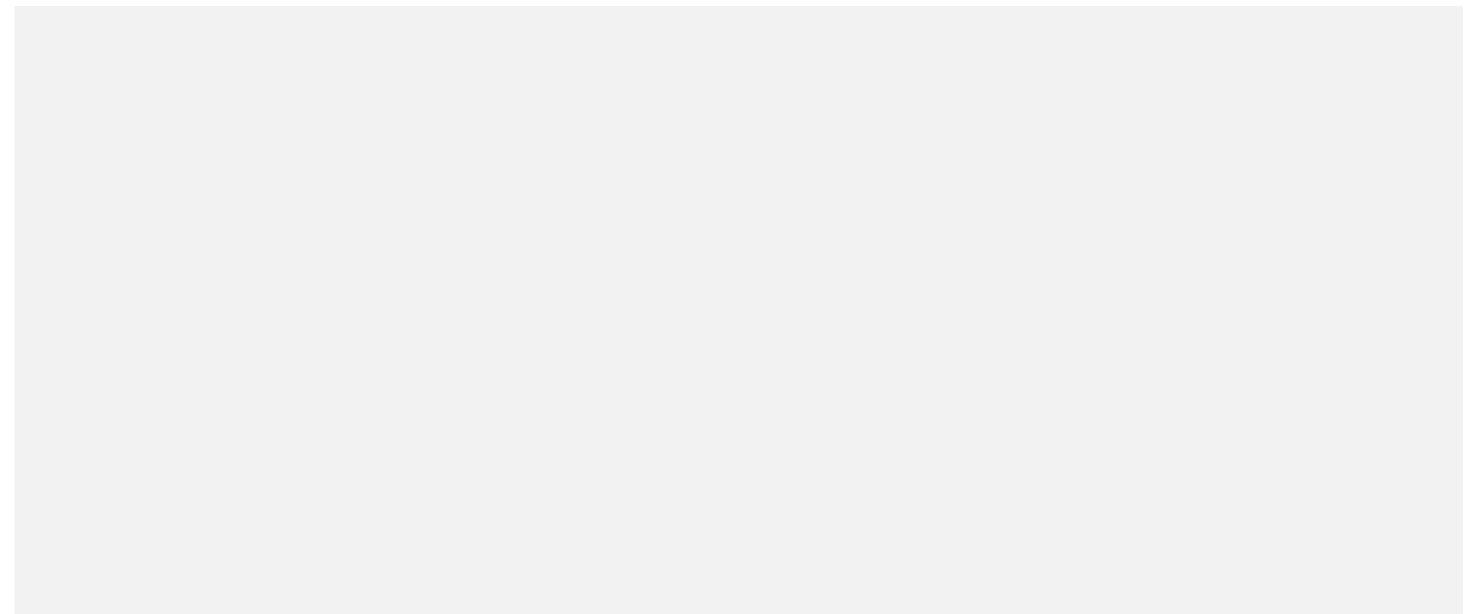

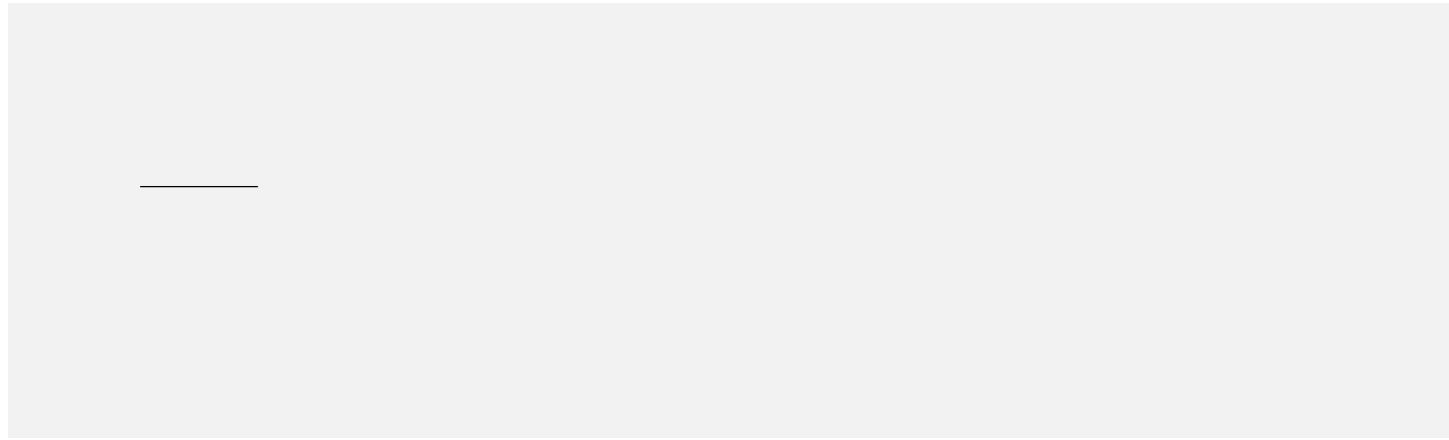

화재하중 _____

Σ

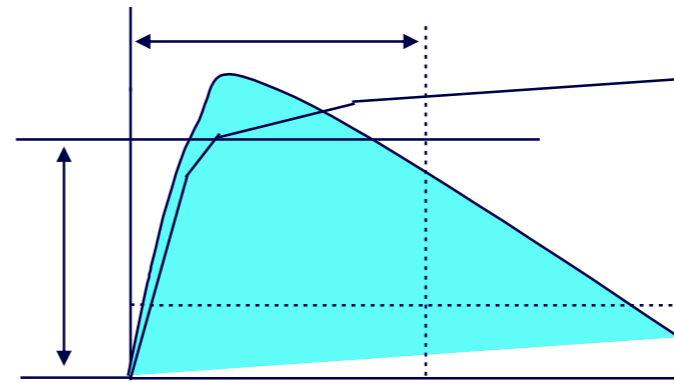

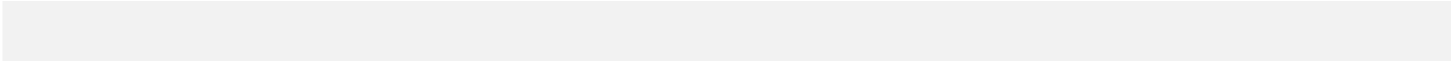
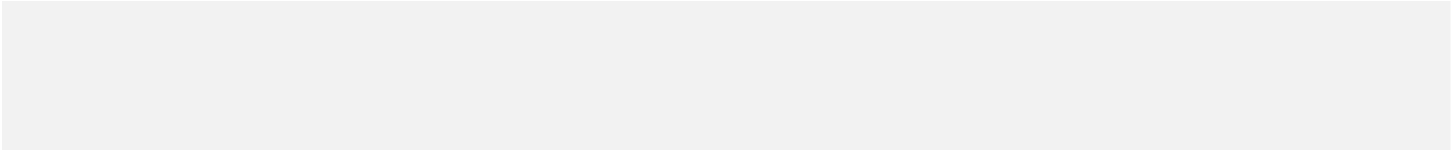

화재하중 _____ _____

화재하중 _____ _____

Σ

화재하중 _____ _____

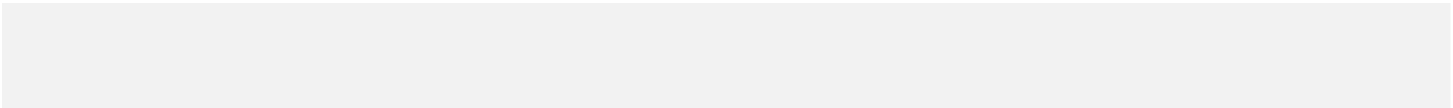

화재하중 _____ _____

Σ

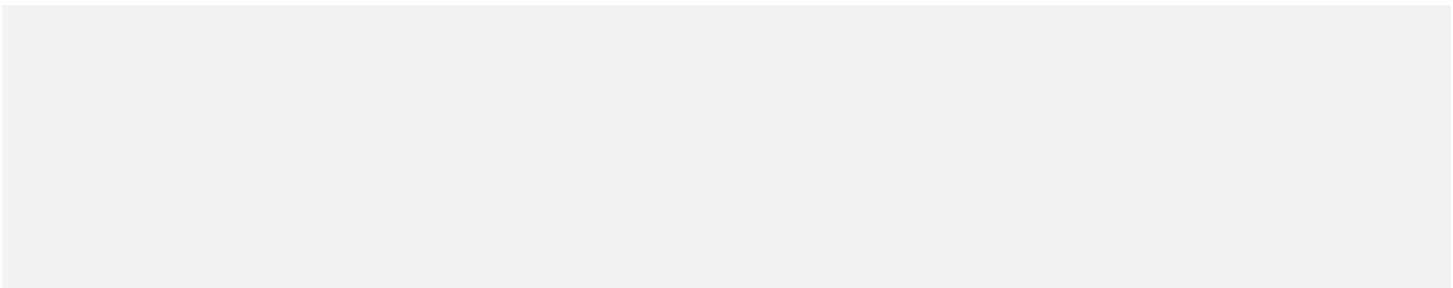
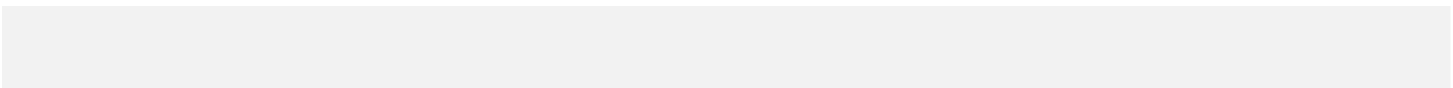

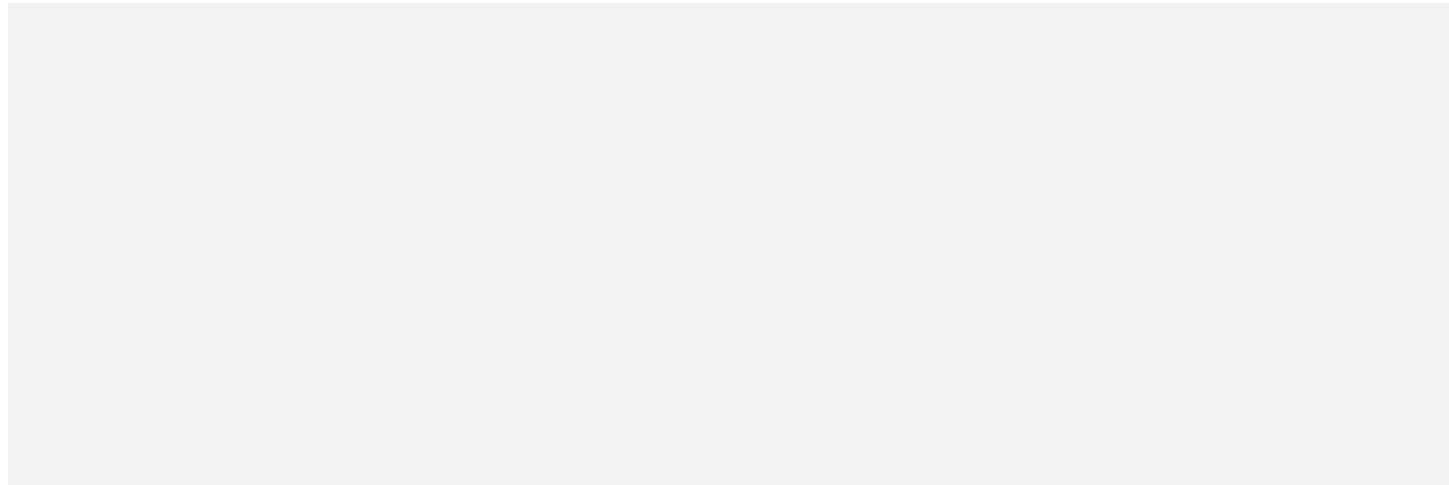

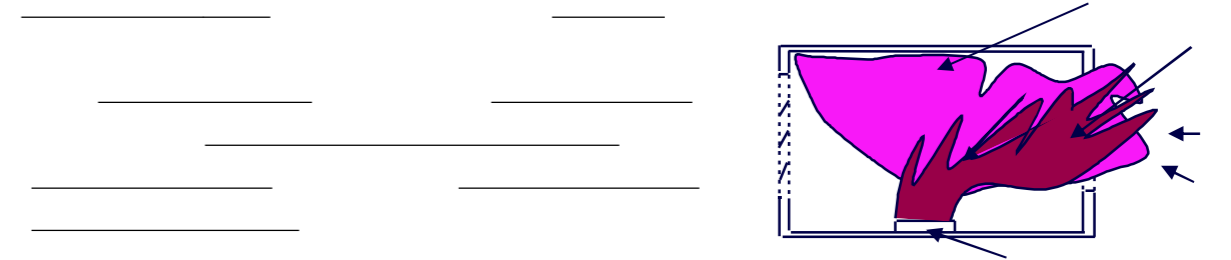
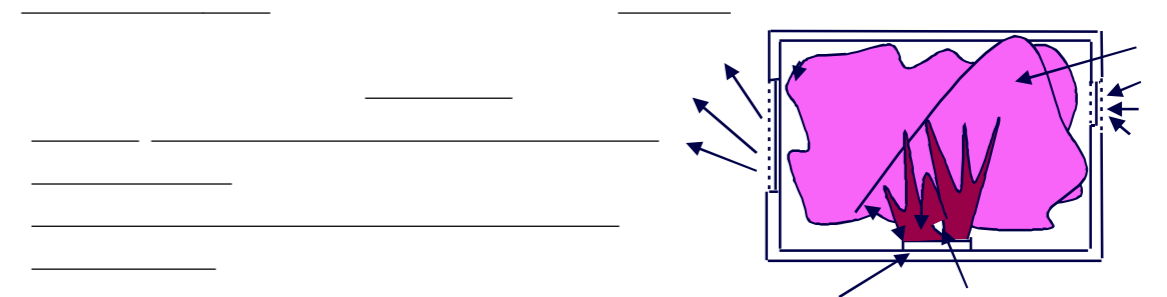

$\sqrt{\quad}$

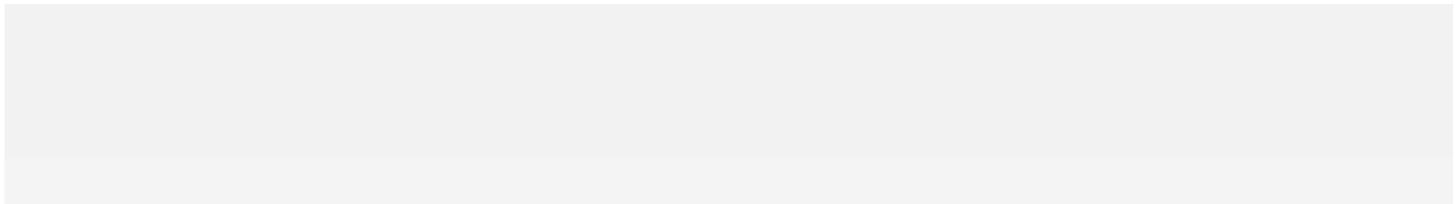

$\sqrt{\quad}$

$\sqrt{\quad}$

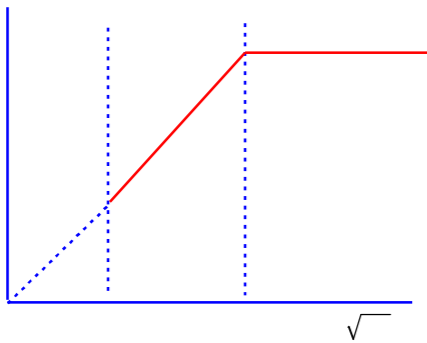

$\sqrt{\quad}$

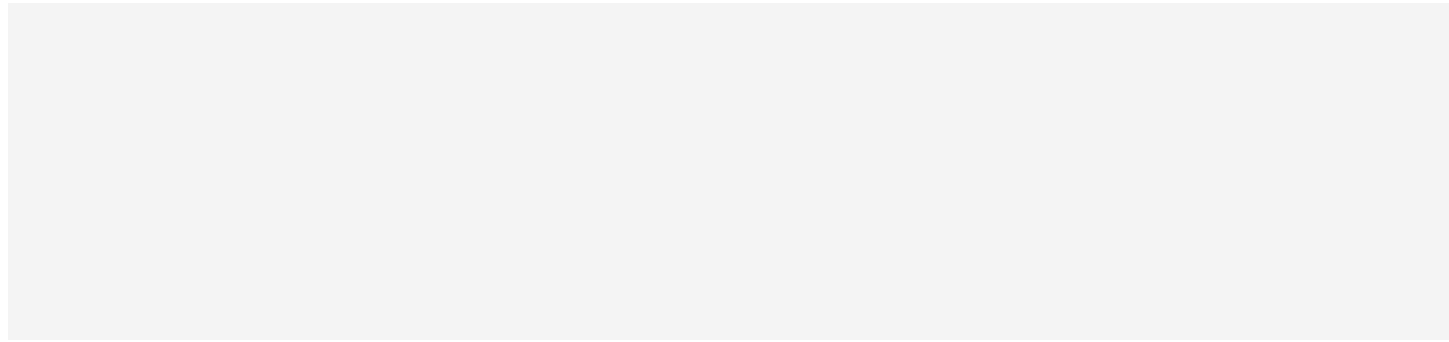

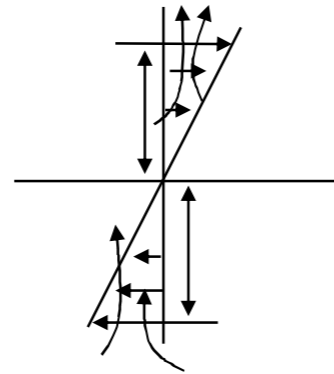

$$\frac{\rho}{\rho}$$

ρ

ρ

←

