



Developer Note

---

# PowerBook Duo 250



Developer Press  
© Apple Computer, Inc. 2000

 Apple Computer, Inc.

© 2000, Apple Computer, Inc.  
All rights reserved.

No part of this publication may be reproduced, stored in a retrieval system, or transmitted, in any form or by any means, mechanical, electronic, photocopying, recording, or otherwise, without prior written permission of Apple Computer, Inc. Printed in the United States of America.

No licenses, express or implied, are granted with respect to any of the technology described in this book. Apple retains all intellectual property rights associated with the technology described in this book. This book is intended to assist application developers to develop applications only for Apple Macintosh computers.

Apple Computer, Inc.  
20525 Mariani Avenue  
Cupertino, CA 95014  
408-996-1010

Apple, the Apple logo, APDA, AppleLink, LaserWriter, Macintosh, and Classic are trademarks of Apple Computer, Inc., registered in the United States and other countries.

Macintosh Quadra, PowerBook, and PowerBook Duo are trademarks of Apple Computer, Inc.

Adobe Illustrator and PostScript are trademarks of Adobe Systems Incorporated, which may be registered in certain jurisdictions.

America Online is a trademark of Quantum Computer Services, Inc.

CompuServe is a registered trademark of CompuServe Inc.

FrameMaker is a registered trademark of Frame Technology Corporation.

Helvetica and Palatino are registered trademarks of Linotype Company.

Internet is a trademark of Digital Equipment Corporation.

ITC Zapf Dingbats is a registered trademark of International Typeface Corporation.

Simultaneously published in the United States and Canada.

#### LIMITED WARRANTY ON MEDIA AND REPLACEMENT

If you discover physical defects in the manual or in the media on which a software product is distributed, APDA will replace the media or manual at no charge to you provided you return the item to be replaced with proof of purchase to APDA.

**ALL IMPLIED WARRANTIES ON THIS MANUAL, INCLUDING IMPLIED WARRANTIES OF MERCHANTABILITY AND FITNESS FOR A PARTICULAR PURPOSE, ARE LIMITED IN DURATION TO NINETY (90) DAYS FROM THE DATE OF THE ORIGINAL RETAIL PURCHASE OF THIS PRODUCT.**

Even though Apple has reviewed this manual, **APPLE MAKES NO WARRANTY OR REPRESENTATION, EITHER EXPRESS OR IMPLIED, WITH RESPECT TO THIS MANUAL, ITS QUALITY, ACCURACY, MERCHANTABILITY, OR FITNESS FOR A PARTICULAR PURPOSE. AS A RESULT, THIS MANUAL IS SOLD "AS IS," AND YOU, THE PURCHASER, ARE ASSUMING THE ENTIRE RISK AS TO ITS QUALITY AND ACCURACY.**

**IN NO EVENT WILL APPLE BE LIABLE FOR DIRECT, INDIRECT, SPECIAL, INCIDENTAL, OR CONSEQUENTIAL DAMAGES RESULTING FROM ANY DEFECT OR INACCURACY IN THIS MANUAL, even if advised of the possibility of such damages.**

**THE WARRANTY AND REMEDIES SET FORTH ABOVE ARE EXCLUSIVE AND IN LIEU OF ALL OTHERS, ORAL OR WRITTEN, EXPRESS OR IMPLIED. No Apple dealer, agent, or employee is authorized to make any modification, extension, or addition to this warranty.**

**Some states do not allow the exclusion or limitation of implied warranties or liability for incidental or consequential damages, so the above limitation or exclusion may not apply to you. This warranty gives you specific legal rights, and you may also have other rights which vary from state to state.**

# Contents

Figures and Tables v

<b>Preface</b>	<b>About This Note</b>	vii
	Conventions Used in This Note	vii
	Other Reference Material	viii
	For More Information	ix
<b>Chapter 1</b>	<b>Introduction to the PowerBook Duo 250 Computer</b>	<b>1</b>
	PowerBook Duo 250 Computer Features	2
<b>Chapter 2</b>	<b>Hardware Modifications</b>	<b>5</b>
	Active-Matrix Display Features	6
	Inverter/Speaker Board	7
	200 MB Hard Disk Drive	7
	Environmental Specifications	8
	Housing Requirements	8
	Hard Disk Interface	11
	Interface Requirements	11
	SCSI Connectors	11
	Terminator	13
	Power Requirements	14
<b>Chapter 3</b>	<b>Software Modifications</b>	<b>15</b>
	PowerBook Duo 250 Control Panels	16
	PowerBook Setup Panel	16
	PowerBook Control Panel	17
	Custom and Easy Controls for Battery Conservation	17
	Power Conservation	18
	<b>Index</b>	<b>19</b>



# Figures and Tables

Chapter 1	Introduction to the PowerBook Duo 250 Computer	1
	<b>Figure 1-1</b>	Simplified block diagram of the PowerBook Duo 250 computer system 3
Chapter 2	Hardware Modifications	5
	<b>Figure 2-1</b>	Hard disk drive housing 9
	<b>Figure 2-2</b>	Bracket for the hard disk drive 10
	<b>Figure 2-3</b>	200 MB hard drive SCSI connector 11
	<b>Table 2-1</b>	Active-matrix display features 6
	<b>Table 2-2</b>	Environmental specifications for 200 MB hard disk drive 8
	<b>Table 2-3</b>	Hard disk SCSI connector signal assignments: SCSI and power 12
	<b>Table 2-4</b>	Hard disk SCSI connector signal assignments: SCSI ID 13
	<b>Table 2-5</b>	SCSI ID encoding 13
	<b>Table 2-6</b>	Power requirements for the 200 MB hard disk drive 14
Chapter 3	Software Modifications	15
	<b>Figure 3-1</b>	PowerBook Setup panel 17
	<b>Figure 3-2</b>	PowerBook Control Panel 18



# About This Note

---

This note is a supplement to the *Macintosh Developer Notes, Number 2, Macintosh Duo System*, APDA publication number R0457LL/A. It describes the design features of the PowerBook Duo 250 computer, which is basically a PowerBook Duo computer with an active-matrix display and expanded hard disk capabilities.

This note provides the hardware or software developer with the additional information needed to design hardware and software elements for the PowerBook Duo 250 computer. This publication assumes you are familiar with the functionality and programming requirements for Apple Macintosh computers. It consists of three chapters

- Chapter 1, "Introduction to the PowerBook Duo 250 Computer"
- Chapter 2, "Hardware Modifications"
- Chapter 3, "Software Modifications"

It also contains an index.

## Conventions Used in This Note

---

This developer note uses the following conventions:

**Note**

A note like this contains information that is interesting but not essential for an understanding of the text. ◆

**IMPORTANT**

A note like this contains information that is essential to an understanding of the text and of the equipment or software described. ▲

▲ **WARNING**

A note like this directs your attention to something that could cause injury to staff, damage to equipment, or loss of data. ▲

A slash in front of a signal name (/RESET) indicates an active low signal.

## P R E F A C E

The following abbreviations are used in the book:

AM	active matrix
DRAM	dynamic random access memory
FSTN	film super twist nematic
I/O	input/output
K	1024
LCD	liquid crystal display
mA	milliampere
MB	megabyte
Mbit	megabit
MHz	megahertz
mm	millimeter
ms	millisecond
μs	microsecond
ns	nanosecond
RAM	random-access memory
RMS	root mean square
SCC	serial communication controller
SCSI	small computer system interface
VRAM	video RAM
V	volts

When unusual abbreviations appear in this developer note, the corresponding terms are also spelled out. Standard units of measure and other widely used abbreviations are not spelled out.

A distinction is made between boards and cards. Boards are a permanent part of the computer or expansion device. Cards may be inserted into the system and can be added or exchanged.

## Other Reference Material

---

Related documentation includes:

- *Macintosh Developer Notes, Number 2, Macintosh Duo System*, APDA publication number R0457LL/A
- *Guide to the Macintosh Family Hardware*, second edition
- *Designing Cards and Drivers for the Macintosh Family*, third edition
- *Inside Macintosh*, Volumes I through VI
- *Macintosh Classic II, Macintosh PowerBook Family, and Macintosh Quadra Family Developer Notes*, APDA publication number R0I43LL/A.



## For More Information

---

APDA is Apple's worldwide source for over three hundred development tools, technical resources, training products, and information for anyone interested in developing applications on Apple platforms. Customers receive the quarterly *APDA Tools Catalog* featuring all current versions of Apple development tools and the most popular third-party development tools. Ordering is easy; there are no membership fees, and application forms are not required for most of our products. APDA offers convenient payment and shipping options, including site licensing.

To order products or to request a complimentary copy of the *APDA Tools Catalog*, contact

APDA  
Apple Computer, Inc.  
P.O. Box 319  
Buffalo, NY 14207-0319

Telephone	800-282-2732 (United States) 800-637-0029 (Canada) 716-871-6555 (International)
Fax	716-871-6511
AppleLink	APDA
America Online	APDA
CompuServe	76666,2405
Internet	APDA@applelink.apple.com



# Introduction to the PowerBook Duo 250 Computer

---

## Introduction to the PowerBook Duo 250 Computer

The Macintosh PowerBook Duo 250 computer is a member of the PowerBook Duo family of computers. It has all the basic features of the PowerBook Duo computer but also has certain new features which are described in this note. These features include

- an active-matrix (AM) 16-level grayscale display
- a 200 MB hard drive
- an inverter/speaker board that is compatible with both film super-twist nematic (FSTN) and AM displays

The computer uses the same 33 MHz 68030 microprocessor as the PowerBook Duo 230 computer. Chapter 2, "Hardware Modifications," describes the modifications made to the original PowerBook Duo computer to implement the PowerBook Duo 250 computer. Chapter 3 describes the software modifications.

This note is a supplement to the *Macintosh Duo System Developer Note, R0457LL/A*, which contains detailed information about the basic Macintosh PowerBook Duo computer.

## PowerBook Duo 250 Computer Features

---

Features of the PowerBook Duo 250 computer are listed below. Items in boldface type are unique to the PowerBook Duo 250 computer, and are described in more detail later in this note. All other items are discussed in detail in the *Macintosh Duo System Developer Note*.

- main processor: 33 MHz 68030 microprocessor
- main system controller (MSC): controls DRAM, ROM, built-in I/O, sound, and some power-saving features
- Power Manager: a custom microcontroller that provides intelligent power management
- integral hard disk: 120 MB or **200 MB capacity**
- 4 MB of DRAM on the main logic board
- DRAM connector: accommodates 4 MB or 8 MB Apple DRAM expansion card, expanding system DRAM capacity to 8 MB or 12 MB; third-party developers using 15-Mbit DRAMs and current packaging techniques can design a card that expands DRAM capacity up to 24 MB
- 1 MB of ROM: stores system and configuration data.
- active-matrix 16-level grayscale display
- video components: a gray-scale controller chip (GSC) and video RAM; the GSC controls the interface between the processor, the Video RAM, and the display; the VRAMs store the data required to write and refresh the display
- **inverter/speaker board** compatible with both FSTN and AM displays
- Combo chip: includes the Serial Communication Controller (SCC) and Small Computer System Interface (SCSI) controller

Introduction to the PowerBook Duo 250 Computer

- sound: enhanced sound chip supports 8-bit monaural sound input and output
- integral microphone and speakers
- modem: internal modem/fax card
- keyboard: integral full-function keyboard with trackball
- I/O: one 152-pin connector for expansion devices, one mini-DIN 8-pin serial port, one modem port, and a power connector
- NiCad battery: three-hour removable and rechargeable battery

Figure 1-1 shows a simplified block diagram of the PowerBook Duo 250 computer system.

**Figure 1-1** Simplified block diagram of the PowerBook Duo 250 computer system

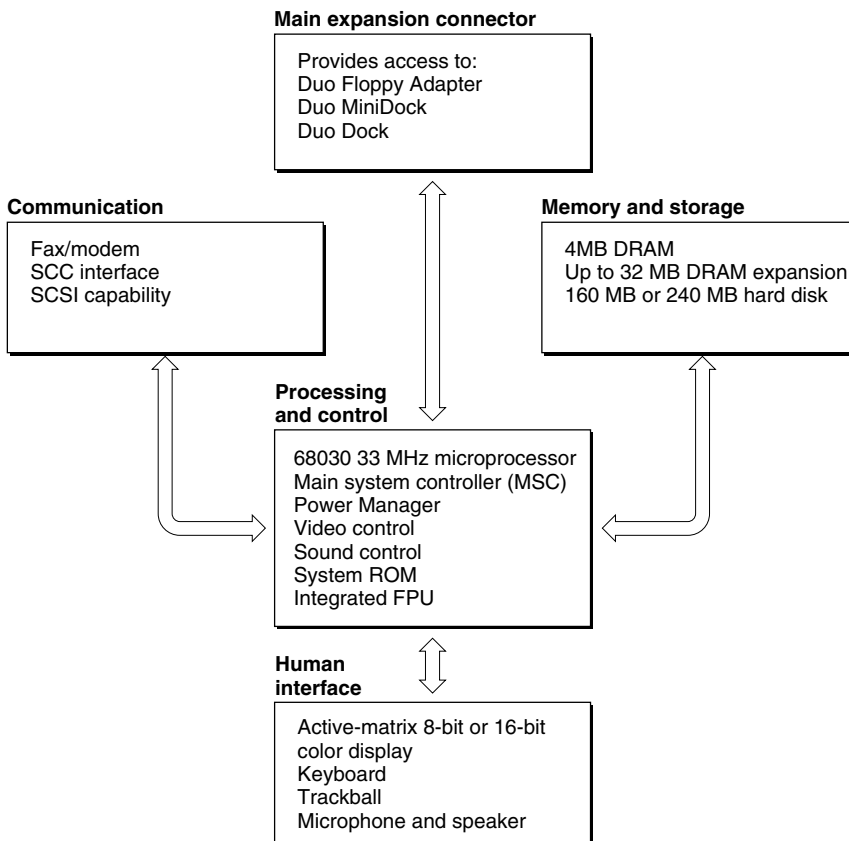



# Hardware Modifications

---

## Hardware Modifications

This chapter describes hardware features of the PowerBook Duo 250 computer that make it different from the Macintosh PowerBook Duo computer. These features include

- the active-matrix display
- the inverter/speaker board
- the 200 MB hard disk drive

## Active-Matrix Display Features

---

The PowerBook Duo 250 display is an active-matrix liquid crystal display. It meets the same form factors as the basic PowerBook Duo display, so no modifications are required to the computer housing. Each pixel in the active-matrix display's 640 x 400 pixel array is controlled by a unique transistor, for a total of 256,000 transistors. The standard display mode is black characters on a white background, simulating the look of a printed page.

With its high contrast ratio of 30:1 and response time of approximately 60 milliseconds, the PowerBook Duo 250 display provides performance similar to that of a CRT video display, with no cursor smearing or cursor submarining. Table 2-1 lists the features of the active-matrix display.

**Table 2-1** Active-matrix display features

<b>Feature</b>	<b>Description</b>
Display matrix	640 x 400 pixels
Active pixel area	192 mm x 120 mm
Display area	199 mm x 127 mm, including black stripe outline
Standard display mode	Black image/characters on white background
Contrast ratio	30:1 minimum
Pixel pitch	0.3 mm square, with black strip between pixels to increase contrast
Pixel on/off switching speed or response time	60 ms typical
Gray scale	16 levels



## Inverter/Speaker Board

---

▲ **WARNING**

You should not open or modify any of the circuitry associated with the inverter/speaker board.

The PowerBook Duo 250 active-matrix display is assembled into the clamshell housing in a clean room environment. Opening up the equipment in any other environment could cause damage to the unit.

The high-voltage inverter/speaker board may pose a risk if you are handling the board.

The LCD display is susceptible to damage from electrostatic discharge (ESD). ▲

The inverter/speaker board is located in the clamshell housing, directly under the LCD. It interfaces between the basic CPU and the active-matrix LCD display and performs the following basic functions for the PowerBook Duo 250 computer:

- It converts the DC power supplied by the computer's battery to the AC power required to drive the cold cathode fluorescent lamp (CCFL), that provides the back-lighting for the active-matrix LCD display. Typical CCFL drive power is 400 VRMS (voltage root mean square) at 3mA, with maximum output of 2000 V peak to peak at 6 mA.
- It provides pass-through circuitry for the data and timing signals, supplied by the GSC to the LCD display, and for the +5 V from the power supply.
- It converts the DC voltage supplied by the computer's battery to the +13 VDC level required for the LCD bias/contrast voltage, which is typically +13 V at 30 mA.

The board is also used in basic PowerBook Duo computers to convert the battery-supplied DC power to the +28V DC level for the LCD bias/contrast voltage required by the film super-twist nematic LCD display.

## 200 MB Hard Disk Drive

---

This section describes the 200 MB hard disk drive. It includes the following information about the drive:

- environmental specifications
- housing requirements
- interface requirements

## Environmental Specifications

---

Table 2-2 provides a summary of environmental specifications for the 200 MB hard disk drive.

**Table 2-2** Environmental specifications for 200 MB hard disk drive

Category	Condition	Specification
Temperature of ambient air inside a low airflow thermal chamber, non-condensing	Operating limits:	5 to 55 degrees C
	Nonoperating and storage:	-40 to 60 degrees C
Temperature gradient	Operating:	20 degrees C per hour
	Non-operating:	Below rate causing condensation
Relative humidity	Operating:	10–90%, noncondensing, maximum wet bulb 20 degrees C
	Non-operating:	Noncondensing, maximum wet bulb 35 degrees C
Altitude	Operating:	–200 to 15,000 feet
	Shipping:	–200 to 15,000 feet

## Housing Requirements

---

The PowerBook Duo 250 computer accommodates either a 120 MB or a 200 MB hard disk drive. The hard disk drive is housed in the PowerBook Duo 250 clamshell housing. Mounting and installation requirements for the 120 MB drive are exactly the same as the requirements described in Chapter 3 of the *Macintosh Developer Notes, Number 2, Macintosh Duo System*.

The 200 MB drive is mounted in the same way as the 120 MB drive but has slightly different dimensions. Figure 2-1 shows the dimensions of the 200 MB hard disk. The height of the disk drive is critical, and it must not exceed 0.75 inches. The drive may be mounted through either side-mounting or bottom-mounting holes machined into the disk drive housing. A bracket, shown in Figure 2-2, is attached to the side of the hard disk and holds it in place in the PowerBook Duo 250 computer housing.

**Figure 2-1** Hard disk drive housing

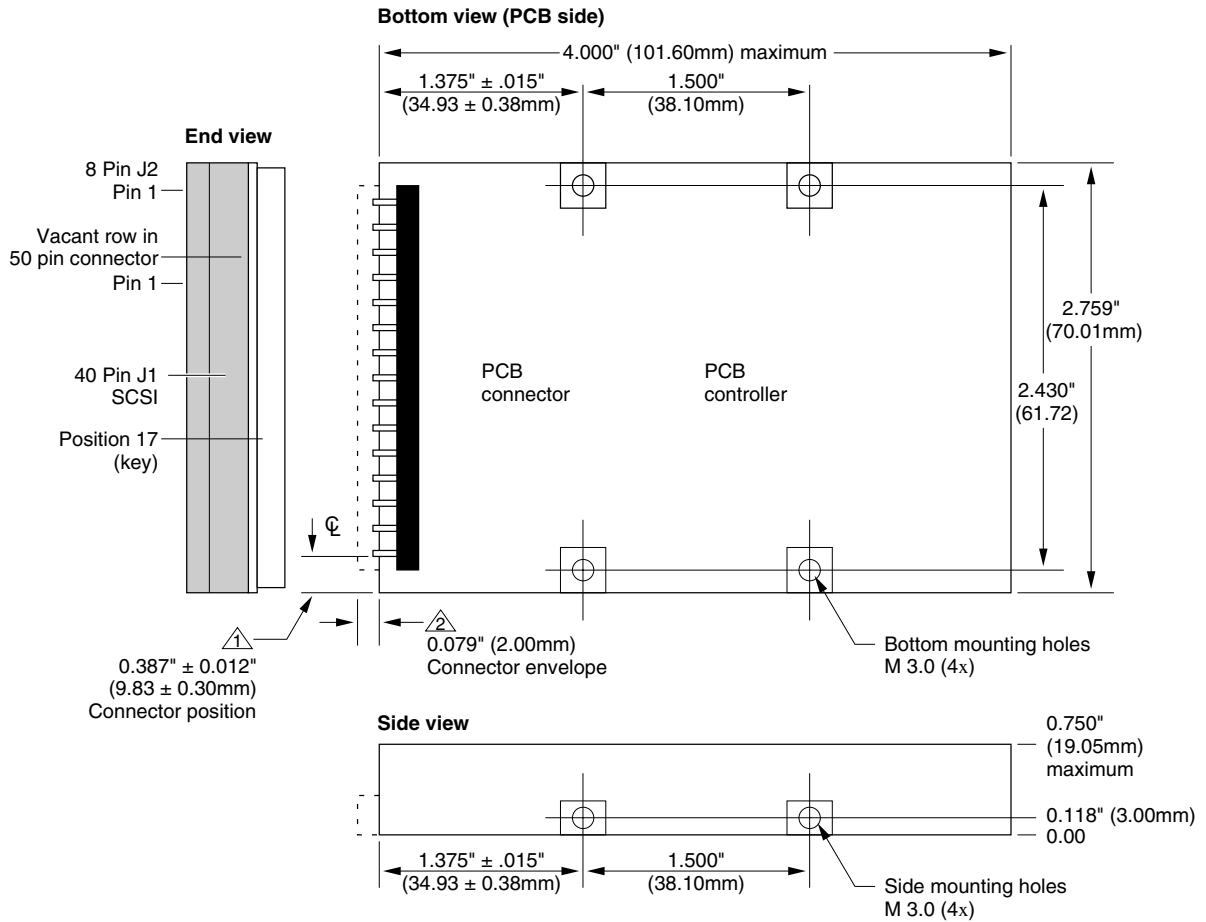

**Notes:**

1. All dimensions in inches (mm).
2. Tolerances (unless otherwise noted): .XX = +/-0.25mm (.XXX = +/- .010 inches).

**Key:**

- ① Connector position from edge of drive to center line of first connector pin (39).
- ② Connector envelope does not include flex cable or mating receptacle. Connector pins are to be flush with drive envelope dimensions.

**Figure 2-2** Bracket for the hard disk drive

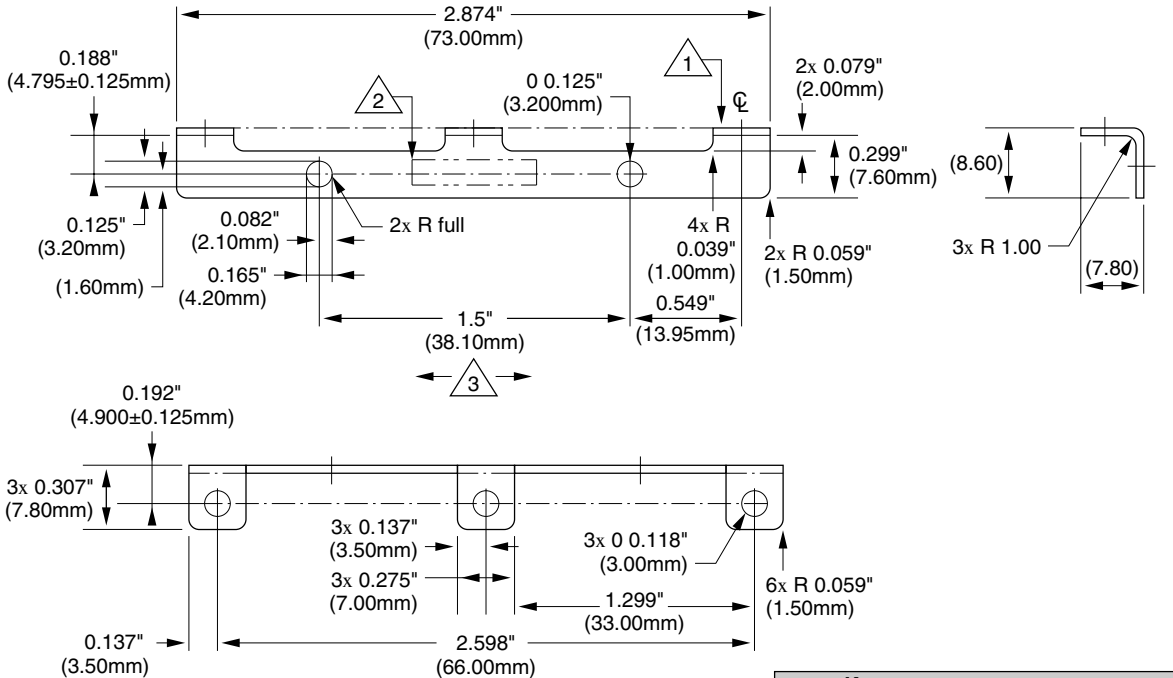

Key	
	This surface to be free of burrs and sharp edges.
	Mark part number, rev level, vendor I.D., and date code with 0.19±0.06 high permanent contrasting characters. Locate where shown.
	Arrow indicates direction of material grain.

**Notes:**

1. Interpret dimensions and tolerances per ANSI Y14.5M-1982
2. Material: CRS 1010-1020, 1.00 ± 0.05 (.0394 ± .0020) thick.
3. Finish: Zinc pre-plate per Mil.Spec. QQ-Z-325a Class 3 (0.00020) type II.
4. Maximum burr allowance is 15% of material thickness.
5. Tooling required to make this part to be property of Apple Computer, Inc. and shall be permanently marked with Apple's name and appropriate part number.
6. All dimensions apply after finish.

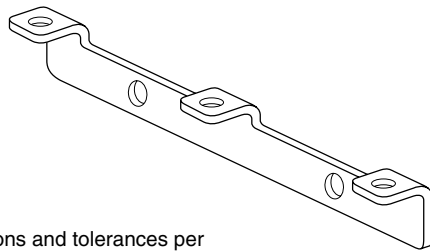

## Hard Disk Interface

This section describes the interface requirements for the 200 MB hard disk drive. It provides specifications and signal assignments for the SCSI connector.

**Note**

The interface requirements for the 120 MB hard disk drive are described in Chapter 3 of the *Macintosh Developer Notes, Number 2, Macintosh Duo System*. ♦

### Interface Requirements

The interface to the hard disk is an ANSC X3T9.2 SCSI interface. It implements the Apple SCSI command protocol and diagnostic command set. The buffer size supports a 1:1 interleave. The drive supports the SCSI asynchronous information transfer. The transfer rate is 1.5 MB per second (minimum). An embedded controller provides error recovery algorithms, which include error check and correction (ECC), seek retry, head offset (for open-loop systems), and defect management. The SCSI interface provides hardware-detectable SCSI ID.

### SCSI Connectors

The 200 MB disk drive SCSI connector comprises two segments, as shown in Figure 2-3. The first segment has 40 pins, arranged in two rows. It transfers SCSI signals between the CPU and the hard disk drive, and it also supplies power to the drive. The second segment of the connector accommodates the SCSI ID.

**Figure 2-3** 200 MB hard drive SCSI connector

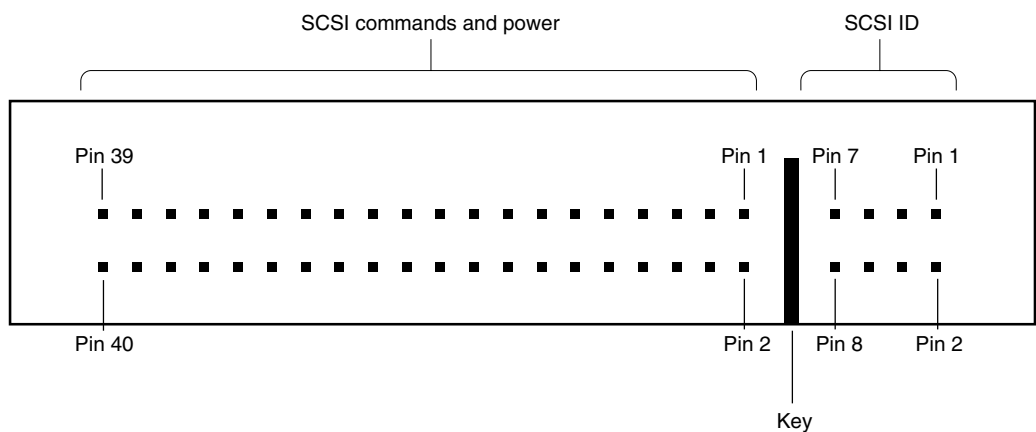

## Hardware Modifications

Table 2-3 lists and describes the interface signals for the 40-pin segment of the connector.

**Table 2-3** Hard disk SCSI connector signal assignments: SCSI and power

Pin	Signal name	Description
1, 2	+5V logic	+5 V power supply
3, 4	Logic return	+5 V return
5, 7, 9, 11, 13, 15, 19, 21, 23, 27, 31, 35	GND	Ground
6	/DB0	Data bus bit 0
8	/DB1	Data bus bit 1
10	/DB2	Data bus bit 2
12	/DB3	Data bus bit 3
14	/DB4	Data bus bit 4
16	/DB5	Data bus bit 5
17	KEY	Not connected; used as connector key
18	/DB6	Data bus bit 6
20	/DB7	Data bus bit 7
22	/PARITY	Data bus parity
24	TERM PWR	Terminator power; pulls up termination resistors for all signal lines
25	/ATN	Attention indicator
26	/BSY	Busy signal
28	/ACK	Acknowledge (handshake signal); asserted in response to a request for access (/REQ)
29	/RST	SCSI bus reset
30	/MSG	Message phase
32	/SEL	SCSI select
33	/I/O	Controls the direction of data movement: when this signal is low, data is output from the disk drive; when it is high, data is input
34	/C/D	Indicates whether data or control signals are on the SCSI bus: when this signal is low, data is on the bus; when it is high, control signals are on the bus
36	/REQ	Access request; the CPU asserts this signal to request access to the hard disk
37, 38	MOTOR RET	Return for +5 V power supply for motor
39, 40	+5V MOTOR	+5 V power supply for the motor

## Hardware Modifications

Table 2-4 lists and describes the interface signals for the 8-pin segment of the connector.

**Table 2-4** Hard disk SCSI connector signal assignments: SCSI ID

Pin	Signal name	Description
1, 2, 3, 4, 8	Unused	These pins are not used and are not connected electrically to the CPU
5	/ID1	SCSI ID 1
6	/ID2	SCSI ID 2
7	/ID4	SCSI ID 4

The internal hard disk is assigned a SCSI ID number (0-7). Pins 5-7 on the SCSI connector are encoded and allow the CPU to select the appropriate device. Table 2-5 shows how the ID signals are encoded.

**Table 2-5** SCSI ID encoding

ID1: Pin 5	ID2: Pin 6	ID4: Pin 7	SCSI ID
High	High	High	0
Low	High	High	1
High	Low	High	2
Low	Low	High	3
High	High	Low	4
Low	High	Low	5
High	Low	Low	6
Low	Low	Low	7

### Terminator

The hard disk has 1000-ohm termination resistors for all I/O signal lines. The lines are pulled up to through the resistors to termination power.

## Power Requirements

Power drawn for the 200 MB hard disk must be less than or equal to values shown in Table 2-6 for each mode. All measurements are under nominal environmental and voltage conditions. The limits include 1000-ohm pull-up resistors on all signal lines.

**Table 2-6** Power requirements for the 200 MB hard disk drive

Mode	Current (amps)		Power (watts)	
	Mean	Maximum	Mean	Maximum
Startup (1)	Not applicable	1.30	Not applicable	6.50
Random operation (2)	0.50	0.60	2.50	3.00
Idle	0.30	0.38	1.50	1.90
Standby	0.20	0.25	1.00	1.25

NOTE 1 Startup values are peak values during response time of Power On to Power Ready.

NOTE 2 Random operation values are RMS values with a 40 percent random seek, 40 percent write/read (1 write in 10 reads) and 20 percent idle mode.



# Software Modifications

---

## Software Modifications

This chapter describes the modifications made to the control panels to support the PowerBook Duo 250 computer.

## PowerBook Duo 250 Control Panels

---

The functions controlled by the PowerBook Duo control panel have been split between two panels: PowerBook Duo Setup, and PowerBook. Having two panels makes it easier to control functions currently available with the PowerBook Duo 250 computer, and leaves room for growth. Dimming has been moved from the panel PowerBook Display, and it is now part of PowerBook. Mirror remains in PowerBook Display.

The first panel, PowerBook Setup, controls setup functions for:

- modem port configuration
- SCSI disk mode
- automatic wakeup

The second control panel, PowerBook, is a power management control panel, and it contains the battery conservation controls, including those items generally available through the Options button in PowerBook version 7.1: sleep, processor cycling, and Econo-Mode. It controls backlight dimming, and it can also automatically change the Power Manager configuration based on the machine's power source.

### PowerBook Setup Panel

---

The PowerBook Duo 250 computer's PowerBook Setup control panel is a modified version of the PowerBook Control Panel that shipped with System 7.1. It is essentially the same control panel, but with all power conservation features removed. It has been further modified to accommodate different modem configurations. The modem controls in the PowerBook Setup control panel distinguish between the Express Modem and other modems. Figure 3-1 shows the modem control panel.

The control panel determines what type of modem is installed and chooses the appropriate control titles. If an Express Modem is present, the title "Internal Modem" is changed to "Compatible" and "External Modem" to "Normal." The functions associated with the radio buttons have not changed. However, the titles are different to remove the confusion generated by the incorrect use of internal/external modem when an Express Modem is installed.

If you have an Express Modem installed, you should typically use the Normal setting. In this mode, the modem is accessed through the Communications ToolBox (CTB). If you are using an application that is not CTB-aware, then you should use the Compatible setting. This will patch the existing serial driver to route serial commands through the CTB to the Express Modem.

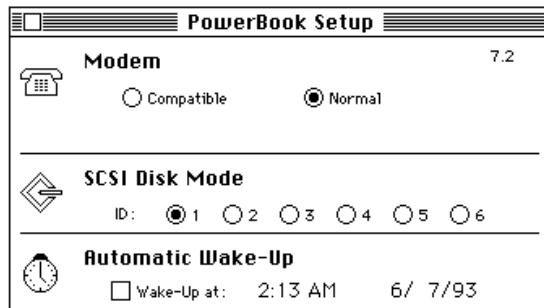
**Figure 3-1** PowerBook Setup panel

If you have a third-party modem installed, the control titles will be Internal Modem/ External Modem, and they will behave accordingly. They are the same as those used in PowerBook 7.1.

**IMPORTANT**

If you select Compatible, port A (Printer/Modem, Modem) is not available for serial connections. AppleTalk is still available. ▲

## PowerBook Control Panel

---

PowerBook control panel is a completely new control panel. It now controls only those functions associated with battery and power conservation, as described in the two following sections. The PowerBook control panel is designed for two different groups of users: those who require the power management procedure to be as simple and transparent as possible; and power users who wish to have complete control over the power management functions.

Information about power management is stored in the Preferences file in the System Folder. When the system is booted, the file is read and the contents stored permanently in memory.

### Custom and Easy Controls for Battery Conservation

---

There are two methods of accessing controls. Initially, if you open the PowerBook control panel, you will see one simple slider switch (Figure 3-2) that controls a number of functions. You may adjust this slider, as required, or leave it in the default position.

However, if you click the Custom button in the control panel, you may then select from additional controls. For example, if you click Custom in the panel that contains the Battery Conservation slider, you will be able to access three additional sliders that are subsets of Battery Conservation. They are System Sleeps, HD Spins Down, and Backlight Dims. If you move any of these sliders, the change will be reflected in the Battery Conservation slider. Feedback will alert you as to whether the changes improve

## Software Modifications

performance or provide better conservation. The controls revert to the single slider if you click the Easy control. The PowerBook Control Panel remembers the state in which the controls were left when last used.

**Figure 3-2** PowerBook Control Panel

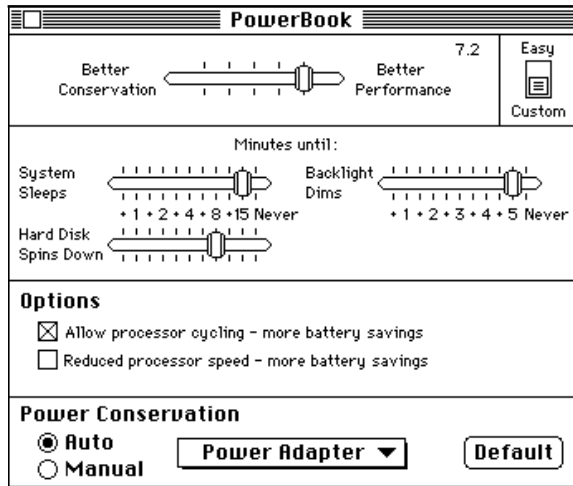

## Power Conservation

There are two modes of battery conservation. One is used when the PowerBook Duo 250 computer is plugged into AC main power, and the other is used when the computer is running on its battery. A TimeMgr task installed by an init in the PowerBook Duo file can automatically change the power management settings based on the machine environment.

When the PowerBook Duo 250 computer is shipped, the power conservation settings in the PowerBook control panel, shown in Figure 3-2, are set with the default settings for Battery and Power Adapter enabled. If you are using Easy mode, the settings used will be the default settings, and you will not be able to edit them. If you are in Custom mode, you can enable or disable automatic conservation, modify both Battery and Power Adapter, or revert to the default settings. To modify the settings, you may choose the set of parameters you wish to change (Battery or Power Adapter) through the pop-up menu, and adjust the sliders. The Power Manager is then reconfigured and the settings stored in the Preferences file.

At certain times, the PowerBook control panel compares the current Power Manager settings with both sets of parameters. It does this during open and activate events, when you switch from Manual to Auto Power Conservation, and when you switch to Custom view. If a match is found, the name of the matching set is displayed in the pop-up menu, and both the menu and the default button are active. If no match is found, No Set Selected is shown in the pop-up menu, and both menu and default button are inactive. Once a valid set is selected, No Set Selected is removed from the pop-up menu.

# Index

---

## A

---

active-matrix display 2, 6  
APDA addresses ix

---

## B

---

battery 3  
battery conservation 17  
    custom controls 17  
    easy controls 17  
battery conservation panel 18  
block diagram 3  
board, inverter/speaker 7  
bracket, hard disk drive 10

---

## C

---

combo chip 3  
Communications ToolBox (CTB) 16  
control panels 16  
conventions used in note vii  
custom controls 17  
custom mode 18

---

## D

---

dimensions, hard disk drive 9  
display 2  
DRAM 2  
DRAM connector 2

---

## E

---

easy controls 17  
easy mode 18  
environmental specifications, hard  
    disk drive 8  
Express Modem 16

---

## F, G

---

fax card 3  
features  
    active-matrix display 6  
    PowerBook Duo 250 computer 2

---

## H

---

hard disk drive 2, 7  
    bracket 10  
    environmental specifications 8  
    housing 9  
    housing requirements 8  
    interface 11  
    power requirements 14  
    SCSI connector 11  
    terminator 13  
hardware modifications 2, 6  
housing, hard disk drive 8, 9

---

## I, J

---

ID encoding, SCSI 13  
installation, hard disk drive 8  
interface, hard disk drive 11  
internal modem 16  
inverter/speaker board 3, 7  
I/O connector 3

---

## K, L

---

keyboard 3

---

## M

---

microphone 3  
modem card 3  
modem control panel 16, 17  
modems 16  
modems, third party 17

modifications  
    hardware 2, 6  
    software 2, 16

---

## N, O

---

new features 2  
NiCad battery 3

---

## P, Q

---

PowerBook control panel 16, 17  
PowerBook Setup control panel 16  
power conservation 18  
power management control  
    panel 16  
Power Manager 2  
power requirements, hard disk  
    drive 14  
Preferences file 17  
processor 2

---

## R

---

reference material viii  
related documentation viii  
ROM 2

---

## S

---

SCSI connector  
    hard disk drive 11  
    signal assignments 12, 13  
SCSI ID encoding 13  
Serial Communication Controller  
    (SCC) 3  
signal assignments, SCSI  
    connector 12, 13  
Small Computer System Interface  
    (SCSI) controller 3  
software modifications 2, 16

## I N D E X

sound 3  
speakers 3  
system block diagram 3  
system controller 2  
system control panel 16  
    modification 16

### T, U

---

terminator, hard disk drive 13  
third-party modems 17

### V, W, X, Y, Z

---

video components 2

